



REHAU TOTAL70 WINDOW AND DOOR SYSTEM

SYSTEM DESCRIPTION

REHAU TOTAL70

THE MORE COMPLETE SYSTEM

The REHAU TOTAL70 Window and Door System comprises of a range of multi-chambered profiles that are designed to meet the requirements of the new build, commercial and domestic refurbishment markets.

There are two aesthetic options to choose from REHAU TOTAL70c is predominantly a Chamfered system with a part sculptured 'T' Sash option and REHAU TOTAL70s is a suite of fully Sculptured profiles.



Also within the REHAU TOTAL70 System are the REHAU TOTAL70MF a suite of Multi-Fold Door profiles and REHAU TOTAL70R a Reversible system, both integrate completely with all of the REHAU TOTAL70 Window and Door System.



The REHAU TOTAL70 Window and Door System can be manufactured in the following window and door types/styles:









- Internally beaded casement window
- Externally beaded casement window*
- Doors – residential, tilt/slide and French doors
- Multi-fold doors
- Tilt and turn window
- Pivot window-horizontal*
- Fully reversible window - horizontal and vertical*
- Conservatory
- Bay and bow window

Glazing thickness from 4 to 44mm can be accommodated (double or triple glazing) 28mm is the more common option. Single glazing can be incorporated as an internally beaded option.

Galvanised steel reinforcement sections are available for the main profiles to meet most specification requirements. The REHAU TOTAL70 system has been proven over many years. The main profiles are extruded in accordance with BS EN 12608. The system holds both the BSI (Kitemark) and is BBA approved.

Range of Colours

REHAU TOTAL70 is available in white and a range of woodgrain laminate options as follows:

	Mahogany		Irish Oak
	Rosewood		Clotted Cream
	Golden Oak		Anthracite Grey
	Simply White		Black Brown

- A further range of woodgrain and solid colour laminate options are available on special order. REHAU TOTAL70s is also available in Mahogany on special order.
- Profiles can also be finished in over 150 RAL colours using the REHAU Acryl II Colour Coating System.

Ancillaries

All ancillary profiles are compatible across the entire REHAU TOTAL70 range for a total solution with limited stock holding requirements.

Fittings

All modern standard fittings and hardware (including shootbolts, hook locks and 'dog' bolts) can be used and are available from various fitting suppliers.

*Doesn't apply to REHAU TOTAL70s

TOTAL 70c

Triple glazing option

4-44mm glazing thickness options

6 chamber outerframe for maximum thermal capability

Additional wall to maximise screw retention

TOTAL 70c

28mm glazing unit

5 chamber outerframe for enhanced thermal performance without compromising on structural capability

5 chamber sash for increased thermal performance

TOTAL 70s

High gloss REHAU material RAU PVC 1406

3 chamber outerframe for maximum structural capability and large reinforcement chamber

Sculptured detail

REHAU TOTAL70

PERFORMANCE

Material

REHAU window profiles are manufactured from high performance, weather-resistant and impact modified RAU PVC 1406. Our renowned high gloss profiles are extruded to CEN A standard and to BS EN 12608 requirements. REHAU has proven itself over fifty years of window system production to be one of the global market leaders in polymer manufacture.

Quality Assurance

REHAU profiles are subjected to the most stringent in-house quality controls incorporating a quality assurance system to BS EN/ISO 9001 ensuring consistency of quality.

Climatic Performance and Security

REHAU systems are tested to the highest levels of performance in all aspects and when it comes to weather performance the REHAU TOTAL70 window and door system is no exception. Independently tested by UKAS accredited test houses, REHAU TOTAL70 window and door system reaches the highest exposure categories under BS 6375 (wind resistance and weather performance) and passes the security standard BS 7950 and PAS 24 (security performance for doors) enabling straightforward compliance to Secure by Design.

Sound insulation

For windows and doors, the sound insulation largely depends on the glazing units used, in particular the variation of glass thickness and air space dimensions.

For example:

Double glazing 4-12-4mm: 30dB

Double glazing 6-12-4mm: 34dB

In general the thicker the glass pane the more sound proof the window will be.

Thermal Performance

Thermal performance in the construction industry has become a major consideration and windows and doors are not exempt from this. Part L (England & Wales) and Part J (Scotland) of the building regulations places strict emphasis on the performance of windows, not only in new build properties, but also the replacement of existing windows.

The REHAU TOTAL70 window and door system is capable of exceeding all current building regulations and can be specified to the highest thermal performing new build projects having achieved values required for Passivhaus installations.

As well as achieving the lowest possible U values, the REHAU TOTAL70 window and door system also achieves the best possible window energy rating (WER) across the range. "A" rated windows are available for both the 70c and 70s systems requiring only common double glazed units to achieve it.



Windows that achieve C ratings or above can be included in the Energy Savings Trust scheme and can display the logo as above.

With the 5 chamber profiles and especially with the thermally enhanced 6 chamber frame, these higher ratings are even more easily achieved.

Enhancing the profile selection improves the overall

thermal performance of the window not only for WERs, but more importantly the U value - its' ability to retain heat within the building. The aim of which is to achieve a cost saving on energy bills as the amount of heating required will be reduced.

Frame	W/m ² K
3 chamber fully reinforced	1.66
3 chamber standard reinforced	1.52
5 chamber fully reinforced	1.48
5 chamber standard reinforced	1.39
6 chamber standard reinforced	1.29

All values are calculated in accordance with BS EN ISO 10077-1 & 2. Frame U values are based on the UK standard window 1230 wide x 1480 high, an opening light next to fixed.

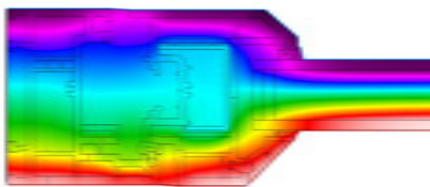
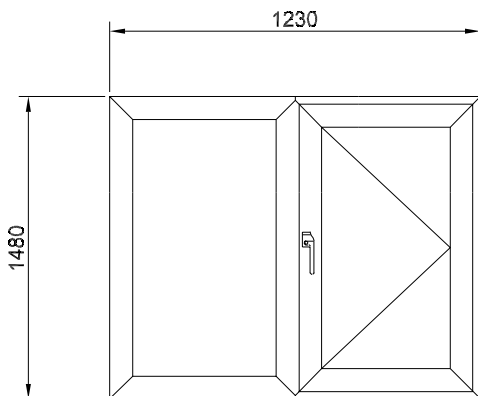

BFRC approved window energy ratings (WER) and FENSA approved U values can quickly and easily be calculated free of charge using the REHAU online thermal calculator www.rehauanswers.com from this energy performance labels can be produced.

Window Energy Rating (WER)

FRAME SUMMARY
REHAU TOTAL70c
 Slim (52mm)
 T Sash (75mm)

GLASS SUMMARY
4/20/4 Float/Argon/K S

A

B

C

D

E

F

G

A

ENERGY INDEX (kWh/m².yr)
WER = 196.7 x ((1-f) x g) - 68.5 x (U + (β.0165 x AL))

UK

The climate zone is:

UK

Window Thermal Transmission (Uw)

Window Solar Factor (gw)

Air Leakage (L)

UK



REHAU
Unlimited Polymer Solutions

This Window Energy Rating has been calculated in accordance with Building Regulations Part L10 2010 section 4.22 and is based on a UK standard window as set out in BRE 443 - Conventions for U value calculations 2006.

All calculations are provided with the best of our knowledge and with the correct information at the date of issue shown at the end of this label. These calculations should be considered as indicative and can be confirmed by an approved simulator of any of the window energy rating scheme bodies if so required.

Working conditions and use under conditions for which the product was not intended and over which we have no influence exclude any claim resulting from our information. We recommend that a check is made as to whether the REHAU product is suitable for the envisaged purpose. Application, use and processing of the products is carried out beyond the scope of our control and are therefore carried out exclusively at your own responsibility. If liability should still apply, then this is regulated, in the case of all damage, by our "Terms and Conditions for Delivery and Payment". This applies also for any claims on warranty, where the warranty applies to the consistent quality of our products as per our specification.

REHAU Ltd
May 2011

REHAU TOTAL70

STYLES AND SHAPES

Window styles and shapes

Fixed light

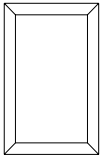

Casement windows including French

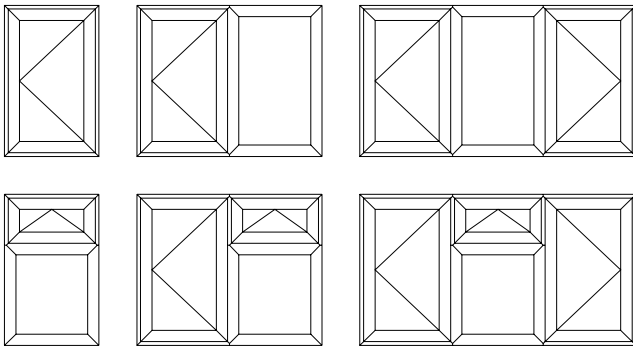

Bay and bow windows

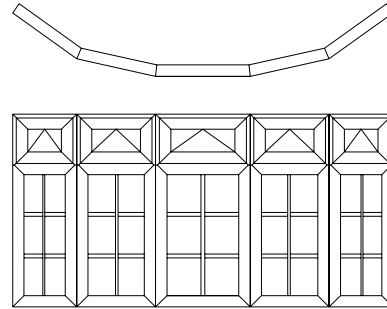

Pivot windows

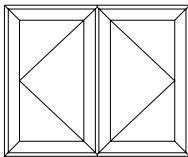
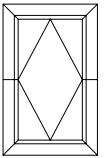

Reversible windows

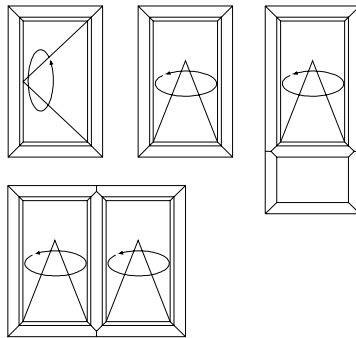

Tilt and turn windows

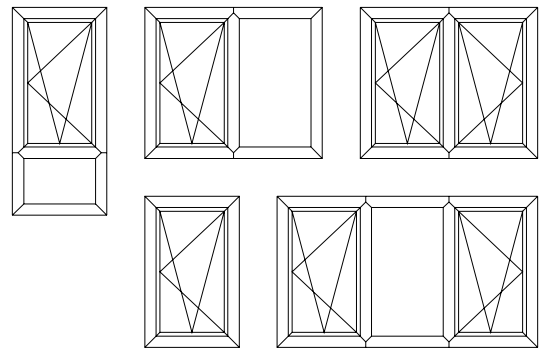

Door styles and shapes

Single leaf doors

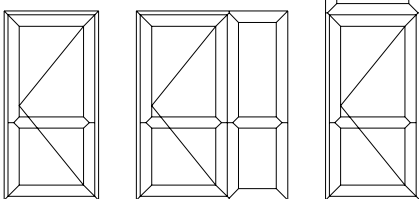

Double leaf doors including French and Tilt & Slide

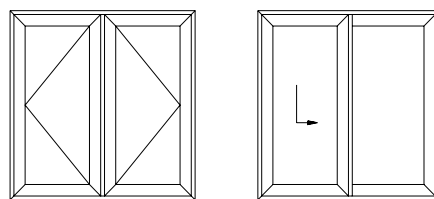

Composite doors

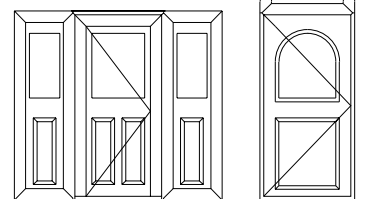

Multi-Fold doors

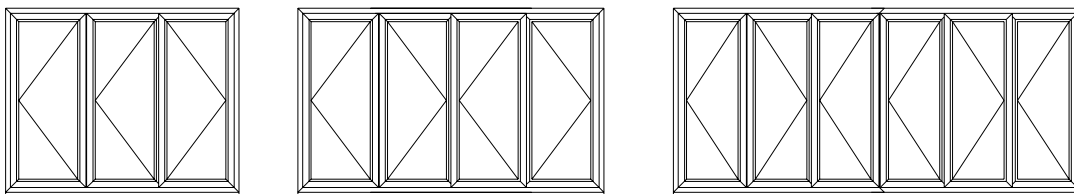

REHAU TOTAL70

MAXIMUM SIZES FOR ELEMENTS AND UNITS



Windows (outer dimension of sash profile)

Sash Style	Colour	Side hung			Top hung			Tilt and Turn			French Windows		
		w x h (m)	a (m ²)	m (kg)	w x h (m)	a (m ²)	m (kg)	w x h (m)	a (m ²)	m (kg)	w x h (m)	a (m ²)	m (kg)
T sash	White	0.9x1.5	1.35	40	1.2x1.2	1.44	40	-	-	-	0.8x1.5	1.2	40
	Woodgrain	0.9x1.5	1.35	40	1.2x1.2	1.44	40	-	-	-	0.8x1.5	1.2	40
Z sash	White	0.9x1.5	1.35	40	1.2x1.2	1.44	40	-	-	-	0.8x1.5	1.2	40
	Woodgrain	0.9x1.5	1.35	40	1.2x1.2	1.44	40	-	-	-	0.8x1.5	1.2	40
Tilt and Turn	White	-	-	-	-	-	-	1.2x1.5	1.8	60	-	-	-
	Woodgrain	-	-	-	-	-	-	1.2x1.5	1.8	60	-	-	-
Reversible	White	0.9x1.2	-	60	1.4x1.4	-	60	-	-	-	-	-	-
	Woodgrain	0.9x1.2	-	60	1.4x1.4	-	60	-	-	-	-	-	-

Doors (outer dimension of door profile)

Sash Style	Colour	Residential Door			French Door			Tilt & Slide			Multi-fold Door		
		w x h (m)	a (m ²)	m (kg)	w x h (m)	a (m ²)	m (kg)	w x h (m)	a (m ²)	m (kg)	w x h (m)	a (m ²)	m (kg)
T Door sash	White	1.0x2.2	-	100	0.85x2.2	-	100	-	-	-	-	-	-
	Woodgrain	1.0x2.1	-	100	0.7x2.1	-	100	-	-	-	-	-	-
Z Door sash	White	1.0x2.2	-	100	0.85x2.2	-	100	1.5x2.3	-	100	0.9x2.1	-	80
	Woodgrain	1.0x2.1	-	100	0.7x2.1	-	100	1.1x2.3	-	100	0.9x2.1	-	80



Maximum sizes shown are calculated using the maximum gauge steel reinforcement shown within the 706.695EN REHAU TOTAL70 Maximum Sash Size Recommendations & Transom, Mullion & Couplers. Windows have been calculated using a windpressure of 2400Pa and Doors 1200Pa. Sizes are subject to instructions provided by fitting suppliers.

White Profile

Max. profile length for fixed lights = 3.0m; max. area = 6.0m²

Max. profile length for multi-lights = 4.0m; max. area = 6.0m²

Tilt and Slide Patio Door; max. area = 8.0m²

Coloured/Woodgrain Profile

Max. profile length for fixed lights = 3m; max. area = 4.0m²

Max. profile length for multi-lights = 3m; max. area = 4.0m²

Tilt and Slide Patio Door; max. area = 6.0m²

Multi-Fold Doors: For details on combinations and overall sizes refer to Multi-fold Door Manufacturing Recommendations 706.708EN/454.

Coupled Subframes: White: With element 'runs' greater than 4.0m in length an expansion joint must be provided.

Coloured/Woodgrain: With element 'runs' greater than 3m in length an expansion joint must be provided.

UK & IRELAND SALES OFFICES

London, REHAU Ltd, The Building Centre, 25 Store Street, London WC1E 7BT Phone: 0207 580 6155 Fax: 0207 307 8595 **Slough**, Units 5 J & K, Langley Business Centre, Station Road, Langley, Slough SL3 8DS Phone: 01753 588500 Fax: 01753 588501 **Manchester**, Brinell Drive, Irlam, Manchester M44 5BL Phone: 0161 777 7400 Fax: 0161 777 7401 **Glasgow**, Phoenix House, Phoenix Crescent, Strathclyde Business Park, Bellshill, North Lanarkshire ML4 3NJ Phone: 01698 503700 Fax: 01698 503701 **Dublin**, 9 St. Johns Court, Business Park, Swords Road, Santry, Dublin 9 Phone: 00353 (0)1 8165020 Fax: 00353 (0)1 8165021

Our verbal and written application engineering advice is based upon experience and the best of our knowledge. However, it is to be regarded as non-binding information. Working conditions and use under conditions for which the product was not intended and over which we have no influence exclude any claim resulting from our information. We recommend that a check is made as to whether the REHAU product is suitable for the envisaged purpose. Application, use and processing of the products is carried out beyond the scope of our control and are therefore carried out exclusively at your own responsibility. If liability should still apply, then this is restricted, in the case of all damage, the value of the goods supplied by us and used by you.

Our warranty applies to the consistent quality of our products as per our specification and in accordance with our general terms and conditions of delivery and payment. This document is protected by copyright. All rights based on this are reserved. No part of this publication may be translated, reproduced or transmitted in any form or by any similar means, electronic or mechanical, photocopying, recording or otherwise, or stored in a data retrieval system.